

Cupsinks & Drain Accessories

Cupsinks

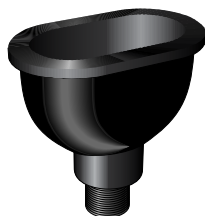

0490-BE Black Epoxy
0490-GE Grey Epoxy
0490-PE Putty Epoxy
0490-SE Slate Epoxy
 Complete with removable strainer. 6"x 3" inside dimension. 1 1/2" I.P.S. male straight thread outlet. (Overall height is 7 1/2")



0491-BP Black Poly
0491-GP Grey Poly
 Complete with removable strainer. 6"x 3" inside dimension. 1 1/2" I.P.S. male straight thread outlet. (Overall height is 8 1/2")



0492-BP Black Poly
0492-GP Grey Poly
 Complete with removable strainer. 9"x 3" inside dimension. 1 1/2" I.P.S. male straight thread outlet. (Overall height is 7")



0493-BE Black Epoxy
0493-GE Grey Epoxy
0493-PE Putty Epoxy
0493-SE Slate Epoxy
 Complete with removable type 316 stainless steel wire screen. 13 3/8" x 4 1/8" x 5 1/4" I.D. 1 1/2" I.P.S. male straight thread outlet. (Overall height is 8")

Stainless Steel Cupsinks



0950-0F Stainless Steel
 Made of type 304 stainless steel and has integral cross bars. 5" I.D. 1 1/2" I.P.S. male straight thread outlet.



0975-0F Stainless Steel
 Made of type 316 stainless steel and has integral cross bars. 6"x 3" I.D. 1 1/2" I.P.S. male straight thread outlet.

Drain Accessories

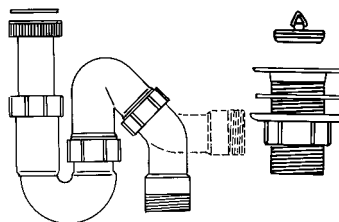

0464-00 Polyethylene Trap and Sink Outlet
 Adjustable riser (tailpiece) can be cut to the desired length. Sink outlet is complete with plug strainer, gasket and locknut. Has a 1 1/2" I.P.S. male straight thread outlet. Running type trap can be used for either "P" or "S" type drain connections. 1 1/2" I.P.S. male straight thread outlet.

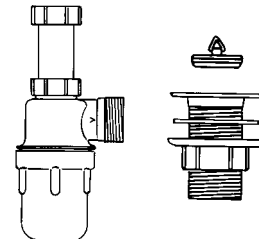

0469-00 Polyethylene Trap and Sink Outlet
 Adjustable riser (tailpiece) with 4 1/2" adjustment that does not require cutting. The sink outlet is complete with plug, strainer, gasket and locknut. Has a 1 1/2" I.P.S. male straight thread outlet. Trap is the bottle "P" type, with removable bottom for cleanout. 1 1/2" I.P.S. male straight thread outlet.

Sink Outlet



0482-BP Black Poly
0482-GP Grey Poly
 Complete with locknut. 1 1/2" I.P.S. male straight thread outlet. For use with epoxy resin tub sinks and troughs.

Sink Overflow



0494BP-04 4" High
0494BP-06 6" High
0494BP-08 8" High
0494BP-10 10" High
 Sink Overflows are designed to be used with 0482-BP sink outlets. 1 1/2" diameter.

St. Steel Sink Drain

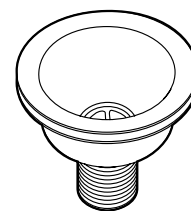

0995-00 Stainless Steel
 Crumb Cup Strainer
 Complete with gaskets, locknut and basket strainer. 1 1/2" male straight thread outlet.

Kemresin Tub Sinks & Drain Troughs

Kemresin® Tub Sinks and Drain Troughs are made from a combination of modified epoxy resins, upgraded for maximum properties with carefully selected curing resins and inert fillers to produce a thermosetting material. They are formed in metal molds to provide one-piece units with coved corners and bottoms pitched to the drain outlet. After being removed

from the molds, they are cured at high temperatures for several hours to complete the chemical reaction, and ensure maximum chemical, impact and thermal shock resistance. Drain outlets are sized for 1 1/2" sink outlets unless otherwise specified.

Kemresin Drain Troughs are molded with no longitudinal joints. A slope of 1/8" per foot assures complete drainage, and a 7/8" cove radius

in the bottom corners is provided for ease of cleaning. Five trough sections, or any part of them, are available to be cemented together to provide Open End Troughs up to 21' long, Closed End Troughs with an end drain outlet up to 21'-8" long and Closed End Troughs with a center drain outlet up to 42'-8" long. Section TR-4 is provided with a center drain recess for a standard 1 1/2" sink outlet.

Epoxy Resin Drain Troughs

Epoxy Resin Tub Sinks



Closed End Trough

Open End Trough



Double Tub Sink

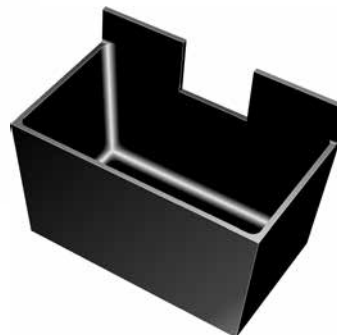

Center Bench End Sink with Trough Cutout



Single Tub Sink

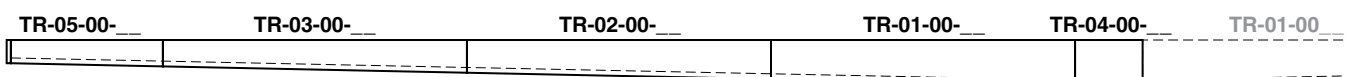
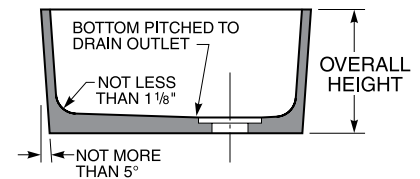
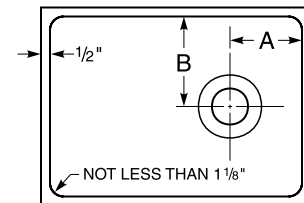
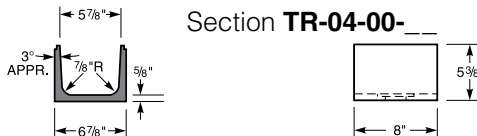
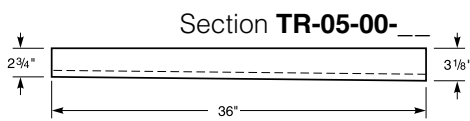
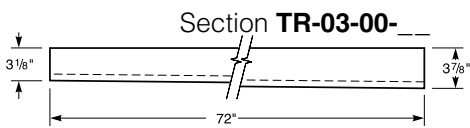
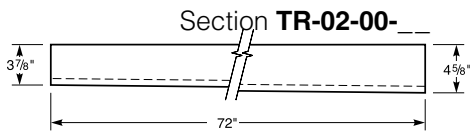
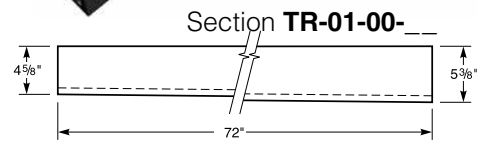

Kemresin Tub Sinks & Drain Troughs

Kemresin Colors

Kemresin® Tub Sinks and Drain Troughs are available in four standard colors: Black, Grey, Putty, and Slate.

To specify color, add color code to the end of the part number.
Example: 1005-00-BK

Color Codes

BK = Black **PT** = Putty
GR = Grey **SL** = Slate

Kemresin Tub Sinks

Catalog Number	Inside Dimensions (at Top of Sink)			Drain Location		Overall Sink Height
	Length	Width	Height	A	B	
1000-00-__	14"	10"	6"	4"	5"	6 ⁷ / ₈ "
1001-00-__	16"	8"	7"	4"	4"	8"
1003-00-__	18"	15"	11 ¹³ / ₁₆ "	4"	4"	12 ⁷ / ₈ "
(1) 1003-DT-__	37"	15"	11"	4 ¹ / ₂ "	4 ¹ / ₂ "	12"
1005-00-__	25"	15"	10"	4"	4"	11 ¹ / ₄ "
1006-00-__	18"	15"	8"	4"	4"	9"
(2) 1006-DT-__	36 ³ / ₄ "	15"	8 ¹ / ₄ "	4 ¹ / ₂ "	4 ¹ / ₂ "	9"
1007-00-__	24"	16"	8"	4"	8"	9 ¹ / ₈ "
1008-00-__	16"	12"	8"	4"	6"	9 ¹ / ₈ "
1011-00-__	18"	6 ¹ / ₂ "	6"	9"	3 ¹ / ₄ "	7"
(3) 1014-00-__	25"	15"	10"	4"	4"	11 ¹ / ₄ "
(4) 1015-00-__	23 ³ / ₈ "	13 ³ / ₄ "	13 ¹ / ₄ "	11 ¹¹ / ₁₆ "	9 ¹ / ₂ "	17 ³ / ₄ "
(5) 1016-00-__	23 ³ / ₈ "	13 ³ / ₄ "	13 ¹ / ₄ "	11 ¹¹ / ₁₆ "	9 ¹ / ₂ "	17 ³ / ₄ "
1021-00-__	16"	16"	7 ¹ / ₂ "	4"	4"	8 ³ / ₄ "
1022-00-__	21"	18"	10"	4 ¹ / ₂ "	9"	11"
1023-00-__	21 ¹ / ₂ "	15 ¹ / ₂ "	7"	4"	4"	8 ³ / ₈ "
1024-00-__	21 ¹ / ₂ "	15 ¹ / ₂ "	11"	4"	4"	12 ¹ / ₈ "
(6) 1024-DT-__	44"	15 ¹ / ₂ "	11"	4"	4"	12 ¹ / ₂ "
1025-00-__	28"	20"	9 ¹ / ₈ "	14"	6"	10 ¹ / ₈ "
1026-00-__	35 ¹ / ₂ "	19 ¹ / ₂ "	10"	17 ³ / ₄ "	9 ³ / ₄ "	11 ¹ / ₈ "
1027-00-__	42"	20"	10"	21"	10"	11 ¹ / ₄ "
1030-00-__	16"	12"	8"	8"	6"	9"
1031-00-__	24"	16"	8"	12"	8"	9"
1032-00-__	29 ³ / ₄ "	14 ³ / ₄ "	6"	14 ⁷ / ₈ "	7 ³ / ₈ "	7"
1034-00-__	21 ¹ / ₂ "	19 ¹ / ₄ "	8"	10 ³ / ₄ "	9 ⁵ / ₈ "	9 ¹ / ₈ "
1035-00-__	45 ³ / ₄ "	17 ³ / ₈ "	12 ¹ / ₂ "	22 ⁷ / ₈ "	8 ³ / ₄ "	13 ³ / ₈ "
1036-00-__	48 ⁵ / ₈ "	24 ¹ / ₂ "	5 ³ / ₈ "	3 ³ / ₄ "	12 ¹ / ₄ "	6"
(7) 1037-00-__	23 ¹ / ₄ "	14 ¹ / ₄ "	12 ³ / ₄ "	11 ⁵ / ₈ "	9 ¹ / ₄ "	22 ³ / ₈ "
(8) 1038-00-__	12" diameter		7 ⁵ / ₈ "	center		8 ³ / ₈ "
(9) 1039-00-__	18" diameter		8 ¹ / ₈ "	center		8 ⁷ / ₈ "
SM-01-00-__	12"	6"	6"	6"	3"	7"
SM-02-00-__	19 ¹ / ₂ "	16 ¹ / ₂ "	8"	9 ³ / ₄ "	8 ¹ / ₄ "	9"
SM-03-00-__	24"	21"	8"	6"	4 ¹ / ₂ "	9 ¹ / ₈ "
SM-04-00-__	25 ¹ / ₂ "	16 ¹ / ₂ "	19"	4 ¹ / ₂ "	4 ¹ / ₂ "	20 ¹ / ₈ "
SM-05-00-__	28"	18"	10"	4"	4"	11 ¹ / ₈ "
SM-06-00-__	28"	18"	10"	24"	4"	11 ¹ / ₈ "
SM-07-00-__	30"	16"	10"	4"	4"	11 ¹ / ₈ "
SM-08-00-__	30"	16"	10"	26"	4"	11 ¹ / ₈ "
SM-09-00-__	30"	18"	18"	4 ¹ / ₂ "	4 ³ / ₄ "	18 ³ / ₄ "
SM-10-00-__	36"	21"	4 ³ / ₄ "	4"	4"	5 ³ / ₄ "
SM-11-00-__	48"	13"	12 ¹ / ₄ "	24"	6 ¹ / ₂ "	13 ¹ / ₄ "
SM-12-00-__	8"	8"	8"	4"	4"	8 ⁷ / ₈ "

- (1) Double tub sink. Distance between centerlines of drain outlets is 19³/₈".
- (2) Double tub sink. Distance between centerlines of drain outlets is 19".
- (3) Sink has 7¹/₈" long by 5⁵/₈" high trough cutout.
- (4) Center table end sink has 7¹/₈" long by 5⁵/₈" high trough cutout and 24¹/₂" long by 3³/₄" high back splash. Table side of sink is not tapered.
- (5) Center table end sink has 24¹/₂" long by 3³/₄" high back splash without trough cutout. Table side of sink is not tapered.
- (6) Double tub sink. Distance between centerlines of drain outlets is 22¹/₂".
- (7) Assembly of tub sink, back splash, ledge and end fillers. Used for T69W4525-00 Scrub Sink Assembly.
- (8) Cylindrical sink – 12" inside diameter at top of sink with center drain outlet.
- (9) Cylindrical sink – 18" inside diameter at top of sink with center drain outlet.
- (10) Sides have 1¹/₂" taper per foot in height.
- (11) Exterior of one 21" long side is not tapered.

Catalog Number	Inside Dimensions (at Top of Sink)			Drain Location		Overall Sink Height
	Length	Width	Height	A	B	
SM-13-00-__	14"	10"	8"	4"	5"	9"
SM-14-00-__	23 ¹ / ₄ "	14 ¹ / ₄ "	12 ³ / ₄ "	11 ⁵ / ₈ "	9 ¹ / ₄ "	13 ⁵ / ₈ "
SM-15-00-__	19 ³ / ₄ "	18"	24"	9 ⁷ / ₈ "	9"	25"
SM-16-00-__	40"	18"	18 ¹ / ₄ "	20"	9"	19 ¹ / ₄ "
SM-17-00-__	29 ³ / ₄ "	23 ¹ / ₂ "	6"	14 ⁷ / ₈ "	11 ³ / ₄ "	7"
SM-18-00-__	18"	15"	15 ¹ / ₄ "	4 ³ / ₄ "	4 ³ / ₄ "	16 ¹ / ₂ "
SM-19-00-__	35 ¹ / ₂ "	19 ¹ / ₂ "	15 ³ / ₈ "	3 ¹ / ₂ "	4 ¹ / ₂ "	16 ¹ / ₂ "
SM-20-00-__	21"	18"	15 ¹ / ₄ "	4 ¹ / ₂ "	4 ¹ / ₂ "	16 ¹ / ₂ "
SM-21-00-__	60 ¹ / ₂ "	22"	7 ¹ / ₄ "	6"	6"	8 ¹ / ₈ "
SM-22-00-__	24"	16"	15 ³ / ₈ "	12"	8"	16 ¹ / ₈ "
SM-23-00-__	28"	18"	15 ¹ / ₂ "	5 ¹ / ₂ "	4"	16 ¹ / ₂ "
SM-24-00-__	48"	8"	8"	24"	4"	9"
SM-25-00-__	21"	18"	15 ¹ / ₈ "	10 ¹ / ₂ "	9"	16 ¹ / ₈ "
SM-26-00-__	21"	11 ³ / ₈ "	15 ¹ / ₈ "	10 ¹ / ₂ "	5 ¹¹ / ₁₆ "	16 ¹ / ₈ "
SM-27-00-__	36"	20"	16 ¹ / ₄ "	18"	10"	17 ¹ / ₄ "
SM-28-00-__	30"	18"	4 ¹ / ₈ "	15"	9"	5 ¹ / ₄ "
SM-29-00-__	36"	24"	12 ¹ / ₄ "	18"	12"	13 ¹ / ₄ "
SM-30-00-__	40"	30"	8 ¹ / ₈ "	20"	15"	9"
SM-31-00-__	24"	15 ³ / ₄ "	12 ¹ / ₈ "	4 ³ / ₄ "	8"	13"
SM-32-00-__	59"	21"	12 ⁵ / ₈ "	29 ¹ / ₂ "	10 ¹ / ₂ "	13 ³ / ₈ "
SM-33-00-__	24"	18"	11"	4"	9"	11 ⁷ / ₈ "
(10) SM-34-00-__	15"	14"	10 ¹ / ₂ "	7 ¹ / ₂ "	7"	11 ¹ / ₄ "
SM-35-00-__	51"	17"	12 ¹ / ₂ "	25 ¹ / ₂ "	8 ¹ / ₂ "	13 ¹ / ₄ "
SM-36-00-__	14"	10"	6"	7"	5"	6 ⁷ / ₈ "
(11) SM-37-00-__	24"	20"	10 ⁵ / ₈ "	6 ³ / ₄ "	10"	11 ¹ / ₄ "
SM-39-00-__	35"	6 ⁵ / ₈ "	4 ³ / ₄ "	17 ¹ / ₂ "	3 ⁵ / ₁₆ "	5 ¹ / ₂ "
SM-40-00-__	33 ³ / ₈ "	29 ¹ / ₈ "	15 ³ / ₄ "	6"	14 ⁹ / ₁₆ "	16 ¹ / ₂ "
SM-41-00-__	18"	15"	8 ¹ / ₄ "	9"	7 ¹ / ₂ "	9"
SM-42-00-__	25"	15"	10 ¹ / ₂ "	12 ¹ / ₂ "	7 ¹ / ₂ "	11 ¹ / ₄ "
SM-43-00-__	21"	18"	10 ³ / ₈ "	10 ¹ / ₂ "	9"	11 ¹ / ₈ "
SM-44-00-__	36"	16"	11"	12"	4"	12"
SM-45-00-__	27 ³ / ₄ "	14 ³ / ₄ "	8 ¹ / ₂ "	10 ¹ / ₂ "	7 ¹ / ₂ "	9 ³ / ₈ "
SM-47-00-__	43"	15 ¹ / ₂ "	11 ¹ / ₈ "	21 ¹ / ₂ "	7 ³ / ₄ "	12"
SM-48-00-__	56"	24"	8 ¹ / ₄ "	28"	12"	9"
SM-49-00-__	36"	16"	8 ³ / ₈ "	6"	8"	9"
SM-50-00-__	24"	24"	12 ¹ / ₂ "	12"	12"	13 ¹ / ₄ "
SM-51-00-__	30"	15 ⁷ / ₈ "	16 ³ / ₈ "	6"	7 ¹⁵ / ₁₆ "	17 ¹ / ₈ "
SM-52-00-__	45 ¹ / ₈ "	11 ¹ / ₂ "	8 ¹ / ₈ "	22 ⁹ / ₁₆ "	5 ³ / ₄ "	9"
SM-53-00-__	31 ¹ / ₂ "	16"	16 ¹ / ₂ "	7 ¹ / ₈ "	8"	17 ¹ / ₄ "
SM-55-00-__	16"	16"	12 ³ / ₈ "	4 ¹ / ₄ "	4 ¹ / ₄ "	13"
SM-56-00-__	42 ¹ / ₄ "	18 ¹ / ₈ "	12 ⁵ / ₈ "	21 ¹ / ₈ "	9 ¹ / ₁₆ "	13 ³ / ₈ "

General Notes:

- Sinks with center drain outlets, except 1011-00, can be furnished with a drain recess sized for a crumb cup strainer or garbage disposal when specified.
- Any sink may be furnished with trough cutout. Specify location and size. (Trough location must be at least 1¹/₂" from inside corner and 2" from bottom.)
- Most sinks can be joined together to form multiple tub sinks provided adjoining sides of sinks are the same size. Sinks longer than 30", wider than 24" or deeper than 12" cannot be factory joined, but they can be factory prepared for field assembly. Assemblies of three or more tub sinks should be no longer than 60" overall. For longer assemblies, one factory joint can be made with a second joint prepared for field assembly.

Kemresin Drop-in Sinks

Kemresin Drop-in Sinks are formed in metal molds to provide a lipped one-piece tub with covered corners and bottoms pitched to the drain outlet. They are made from a combination of modified epoxy resins, upgraded for maximum properties with carefully selected curing resins and inert fillers to produce a thermosetting

material. After being removed from the molds, they are cured at high temperatures for several hours to complete the chemical reaction, and ensure maximum chemical, impact and thermal shock resistance. Drain outlets are sized for 1/2" sink outlets unless otherwise specified.

They are designed to be mounted in Kemresin tops in a specially rabbetted cutout so that no support from below is required.

Drop-in Kemresin Sinks

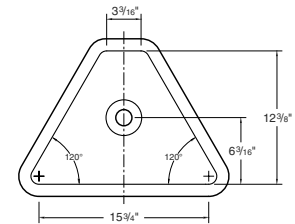
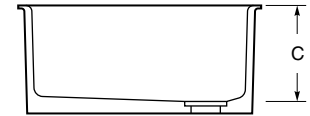
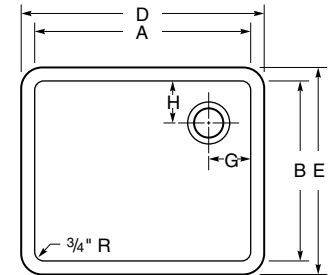
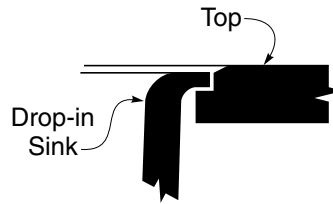

PLAN VIEW
1048-DI-

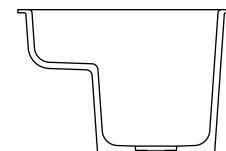

SECTION VIEW
1049-DI-

Part Number	I.D.		Depth	O.D.		Drain Location	
	A	B	C	D	E	G	H
1000-DI- ___	13 ⁷ / ₈ "	9 ⁷ / ₈ "	6"	16 ¹ / ₈ "	12 ¹ / ₈ "	7"	5"
1001-DI- ___	8"	16"	7"	10 ¹ / ₄ "	18 ¹ / ₄ "	4"	4"
1003-DI- ___	17 ¹⁵ / ₁₆ "	14 ¹⁵ / ₁₆ "	11"	20 ³ / ₁₆ "	17 ³ / ₁₆ "	3 ¹ / ₂ "	3 ¹ / ₂ "
1005-DI- ___	25"	15"	10"	27 ¹ / ₄ "	17 ¹ / ₄ "	4"	4"
1006-DI- ___	17 ⁷ / ₈ "	14 ⁷ / ₈ "	8"	20 ¹ / ₈ "	17 ¹ / ₈ "	3 ¹ / ₂ "	3 ¹ / ₂ "
1008-DI- ___	16"	12"	8"	18 ¹ / ₄ "	14 ¹ / ₄ "	4"	6"
1011-DI- ___	18"	6 ¹ / ₂ "	6"	20 ¹ / ₄ "	8 ³ / ₄ "	9"	3 ¹ / ₄ "
1021-DI- ___	16"	16"	7 ¹ / ₂ "	18 ¹ / ₄ "	18 ¹ / ₄ "	4"	4"
1022-DI- ___	21"	18"	10"	23 ¹ / ₄ "	20 ¹ / ₄ "	4"	9"
(1) 1038-DI- ___	12" diameter		7 ⁵ / ₈ "	14 ¹ / ₄ " diameter		center center	
(2) 1039-DI- ___	18" diameter		8 ¹ / ₈ "	20 ¹ / ₄ " diameter		center center	
1040-DI- ___	15 ³ / ₈ "	11 ³ / ₈ "	8"	17.6"	13.6"	4"	4"
1041-DI- ___	23 ³ / ₈ "	15 ³ / ₈ "	8.3"	25.6"	17.6"	4"	4"
1042-DI- ___	28"	15"	11.8"	30 ¹ / ₄ "	17 ¹ / ₄ "	5"	5"
1043-DI- ___	30"	16"	17.8"	32 ¹ / ₄ "	18 ¹ / ₄ "	5"	8"
1044-DI- ___	12"	8"	6"	14 ¹ / ₄ "	10 ¹ / ₄ "	6"	4"
1045-DI- ___	21"	17"	10"	23 ¹ / ₄ "	19 ¹ / ₄ "	4 ¹ / ₂ "	8 ¹ / ₂ "
1046-DI- ___	21 ¹ / ₂ "	15 ¹ / ₂ "	11"	23 ³ / ₄ "	17 ³ / ₄ "	4"	4"
1047-DI- ___	24"	18"	11"	26 ¹ / ₄ "	20 ¹ / ₄ "	4"	4"
(3) 1048-DI- ___	17 ¹ / ₂ "	12 ³ / ₈ "	6 ¹ / ₂ "	19 ¹ / ₂ "	14 ⁵ / ₈ "	8 ³ / ₄ "	6 ³ / ₁₆ "
(4) 1049-DI- ___	18"	15"	11"	20 ¹ / ₄ "	17 ¹ / ₄ "	4 ¹ / ₂ "	5"
1070-DI- ___	24"	16"	15 ¹ / ₂ "	26 ¹ / ₄ "	18 ¹ / ₄ "	12"	8"
ADA Compliant							
1000-ADA-DI- ___	13 ⁷ / ₈ "	9 ⁷ / ₈ "	5"	16 ¹ / ₈ "	12 ¹ / ₈ "	4"	4"
1005-ADA-DI- ___	25"	15"	4.8"	27 ¹ / ₄ "	17 ¹ / ₄ "	4"	4"
1006-ADA-DI- ___	17 ⁷ / ₈ "	14 ⁷ / ₈ "	5"	20 ¹ / ₈ "	17 ¹ / ₈ "	3 ¹ / ₂ "	3 ¹ / ₂ "

(1) Cylindrical sink, 12" inside diameter
(2) Cylindrical sink, 18" inside diameter

(3) Triangular sink used in X92 and X94 assemblies
(4) Stepped sink, 4³/₄" deep at front

Kemresin Colors

Kemresin® Drop-in Sinks are available in four standard colors: Black, Grey, Putty, and Slate.

To specify color, add color code to the end of the part number.
Example: 1005-DI-BK

Color Codes

BK = Black **PT** = Putty
GR = Grey **SL** = Slate

Research Collection

Stainless Steel Drop-in Sinks

Seamless die-drawn from nickel bearing type 304, 18-8, 18 gauge stainless steel. Allows easy cleaning and stain resistance. Interior and top surfaces polished to a gleaming finish with a highlighted bowl rim. Corners and bottom turns are radiused $1\frac{3}{4}$ ". Sinks are thoroughly sound deadened with environmentally

safe compounds, to ensure proper sound insulation and to reduce condensation.

All sinks are self-rimming with stainless steel mounting channels for easy, top mount, snap-in clip installation. Sinks are compatible with any type work-surface material from $\frac{3}{4}$ " to $2\frac{1}{2}$ " thick.

Each sink is center punched to receive a standard cup strainer. ADA compliant sinks are punched in the center, $4\frac{1}{2}$ " from the rear of the bowl for extra clearance.

Stainless Steel Sinks

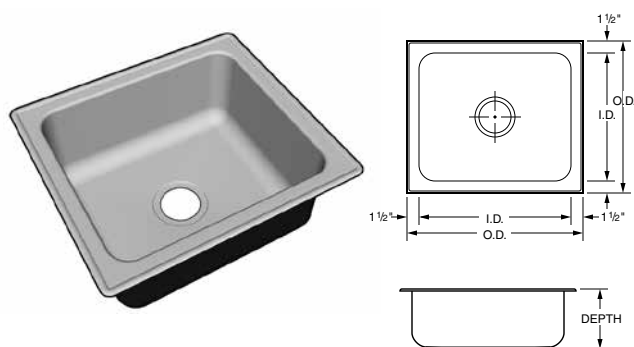

Part Number	O.D.		I.D.		Sink Depth
	Front to Back	Side to Side	Front to Back	Side to Side	
F-5353-08	15"	15"	12"	12"	7 $\frac{1}{2}$ "
F-5354-08	17"	19"	14"	16"	7 $\frac{1}{2}$ "
F-5355-08	19"	22"	16"	19"	7 $\frac{1}{2}$ "
F-5356-08	19"	25"	16"	22"	7 $\frac{1}{2}$ "
F-5357-08	19"	31"	16"	28"	7 $\frac{1}{2}$ "
F-5353-09	15"	15"	12"	12"	9"
F-5354-11	17"	19"	14"	16"	10 $\frac{1}{2}$ "
F-5355-11	19"	22"	16"	19"	10 $\frac{1}{2}$ "
F-5356-11	19"	25"	16"	22"	10 $\frac{1}{2}$ "
F-5357-11	19"	31"	16"	28"	10 $\frac{1}{2}$ "
F-5354-12	17"	19"	14"	16"	12"
F-5355-12	19"	22"	16"	19"	12"
F-5356-12	19"	25"	16"	22"	12"
F-5357-12	19"	31"	16"	28"	12"

Stainless Steel Sinks with Fixture Ledge

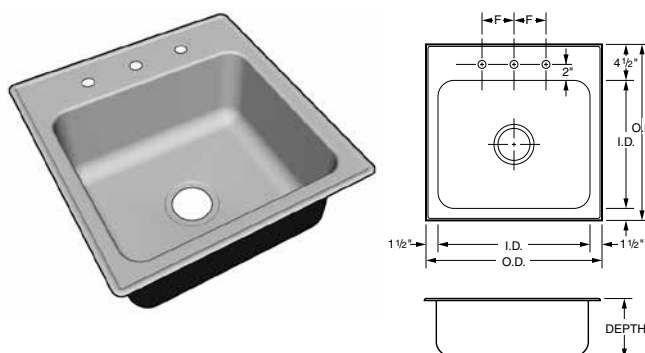

Part Number	O.D.		I.D.		Sink Depth	Fixture Centers
	Front to Back	Side to Side	Front to Back	Side to Side		
F-5358-08	18"	15"	12"	12"	7 $\frac{1}{2}$ "	4"
F-5359-08	20"	19"	14"	16"	7 $\frac{1}{2}$ "	6"
F-5360-08	22"	22"	16"	19"	7 $\frac{1}{2}$ "	6"
F-5361-08	22"	25"	16"	22"	8"	8"
F-5362-08	22"	31"	16"	28"	7 $\frac{1}{2}$ "	8"
F-5358-09	18"	15"	12"	12"	9"	4"
F-5359-11	20"	19"	14"	16"	10 $\frac{1}{2}$ "	6"
F-5360-11	22"	22"	16"	19"	10 $\frac{1}{2}$ "	6"
F-5361-11	22"	25"	16"	22"	10 $\frac{1}{2}$ "	8"
F-5362-11	22"	31"	16"	28"	10 $\frac{1}{2}$ "	8"
F-5360-12	22"	22"	16"	19"	12"	6"
F-5361-12	22"	25"	16"	22"	12"	8"
F-5362-12	22"	31"	16"	28"	12"	8"

ADA Compliant

Part Number	O.D.		I.D.		Sink Depth
	Front to Back	Side to Side	Front to Back	Side to Side	
F-5353-06	15"	15"	12"	12"	5 $\frac{1}{2}$ "
F-5354-06	17"	19"	14"	16"	5 $\frac{1}{2}$ "
F-5355-06	19"	22"	16"	19"	5 $\frac{1}{2}$ "
F-5356-06	19"	25"	16"	22"	5 $\frac{1}{2}$ "
F-5357-06	19"	31"	16"	28"	5 $\frac{1}{2}$ "

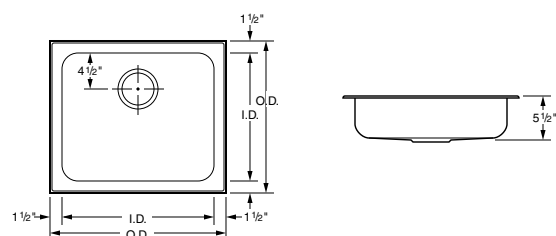

ADA Compliant with Fixture Ledge

Part Number	O.D.		I.D.		Sink Depth	Fixture Centers
	Front to Back	Side to Side	Front to Back	Side to Side		
F-5358-06	18"	15"	12"	12"	5 $\frac{1}{2}$ "	4"
F-5359-06	20"	19"	14"	16"	5 $\frac{1}{2}$ "	6"
F-5360-06	22"	22"	16"	19"	5 $\frac{1}{2}$ "	6"
F-5361-06	22"	25"	16"	22"	5 $\frac{1}{2}$ "	8"
F-5362-06	22"	31"	16"	28"	5 $\frac{1}{2}$ "	8"

