

# Alpha System Carts

## Features:

- The adaptability of the Alpha System and the convenience of mobility
  - Standard double-slotted uprights mounted on heavy gauge steel frame
  - Available with large diameter, heavy duty casters or glides
  - Available with or without overhead carrier
  - Available in all standard module lengths – from 24" to 72"
- Accepts standard Alpha System components including:
- Adjustable Height Cantilevered Worksurface Frames
    - for supporting Worksurface Top and Suspended Base Cabinets
    - easily positioned on 1" increments
  - Adjustable Module Shelving
    - available in five depths
    - available in steel, wood, and phenolic resin
    - available with or without retaining lips
    - adjustable on 1" increments

## SEFA 10 | Class 8 – Configuration 1 – Category 1

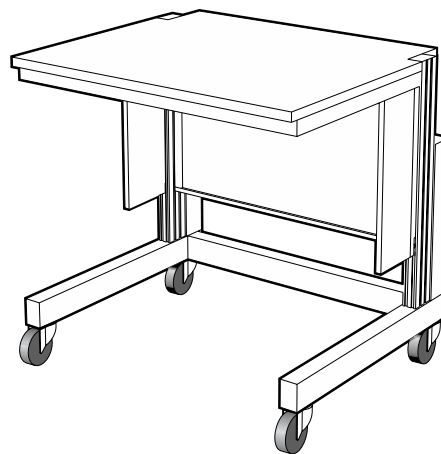
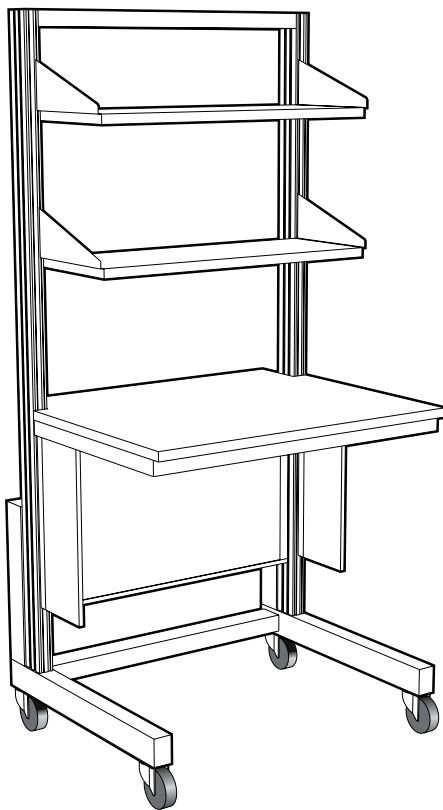

Select Alpha System Cart frame components and Worksurface Tops from the following two pages. Select Adjustable Module Shelves from pages 51-56

Cantilevered Worksurface Frames from pages 58 and 59, suspended base cabinets from pages 100 through 108 and suspended upper cabinets from pages 136 through 141.

# Alpha System Carts

**Specifications:**

Alpha System Carts incorporate the same double slotted uprights used in the Alpha System Structural Modules. The uprights are mounted to a base fabricated of steel tubing and mounted on 4" diameter casters or glides. This creates a mobile system designed to support both the same Cantilevered Worksurface Frames and Adjustable Shelves used on the Structural Support Modules.

The Alpha System Cart is 37" high, with Upper Carrier 78" high. Both are 30" deep and available in lengths shown.

**Worksurface Frame, Top and Adjustable Shelves must be ordered separately.**

**Alpha System Cart**

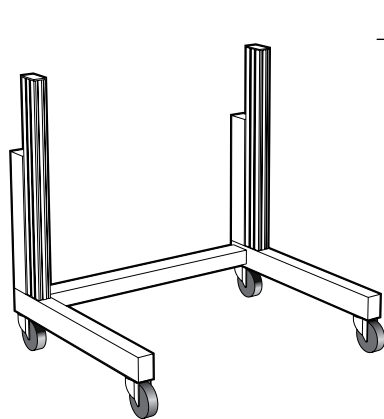

Length	with Caster	with Glides
24"	<b>F57-3724-0C</b>	<b>F57-3724-0G</b>
30"	<b>F57-3730-0C</b>	<b>F57-3730-0G</b>
36"	<b>F57-3736-0C</b>	<b>F57-3736-0G</b>
42"	<b>F57-3742-0C</b>	<b>F57-3742-0G</b>
48"	<b>F57-3748-0C</b>	<b>F57-3748-0G</b>
54"	<b>F57-3754-0C</b>	<b>F57-3754-0G</b>
60"	<b>F57-3760-0C</b>	<b>F57-3760-0G</b>
66"	<b>F57-3766-0C</b>	<b>F57-3766-0G</b>
72"	<b>F57-3772-0C</b>	<b>F57-3772-0G</b>

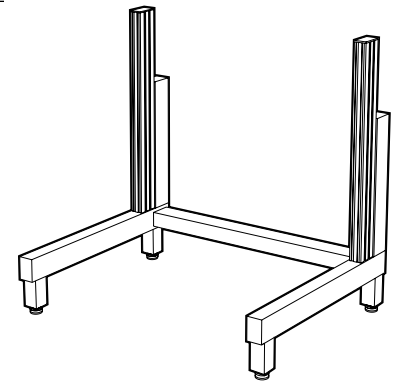

**Alpha System Cart with Upper Carrier**

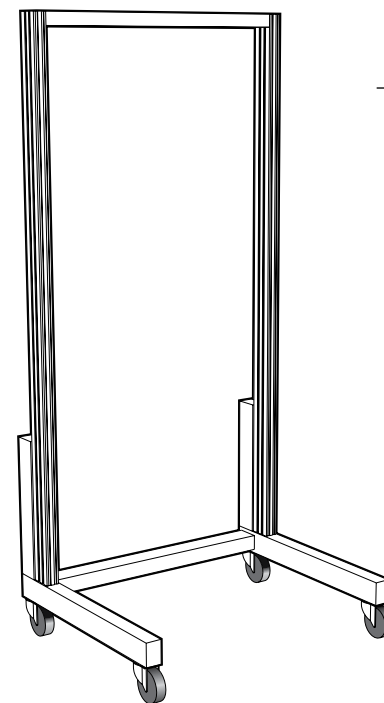

Length	with Casters	with Glides
24"	<b>F57-7824-0C</b>	<b>F57-7824-0G</b>
30"	<b>F57-7830-0C</b>	<b>F57-7830-0G</b>
36"	<b>F57-7836-0C</b>	<b>F57-7836-0G</b>
42"	<b>F57-7842-0C</b>	<b>F57-7842-0G</b>
48"	<b>F57-7848-0C</b>	<b>F57-7848-0G</b>
54"	<b>F57-7854-0C</b>	<b>F57-7854-0G</b>
60"	<b>F57-7860-0C</b>	<b>F57-7860-0G</b>
66"	<b>F57-7866-0C</b>	<b>F57-7866-0G</b>
72"	<b>F57-7872-0C</b>	<b>F57-7872-0G</b>

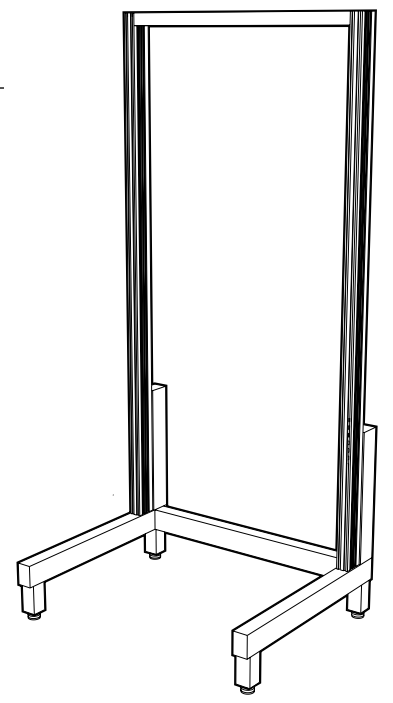

# Alpha System Carts

## Specifications:

Alpha System Cart Worksurface Tops are available in modular sizes to match the length and depth of the Worksurface Frames. Worksurface Tops are 1" thick. Front edges are treated as shown on page 69. All other edges are finished square.

### Electrical Service Strip & Modesty Panel for Alpha System Cart

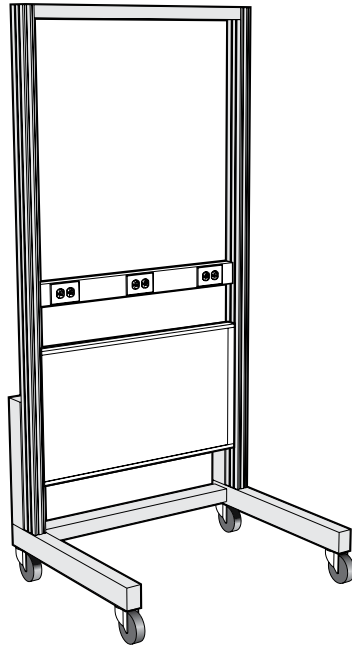

Length	Electrical Service Strip	Duplex Outlets
24"	<b>F56M0324-00</b>	2
30"	<b>F56M0330-00</b>	2
36"	<b>F56M0336-00</b>	3
42"	<b>F56M0342-00</b>	3
48"	<b>F56M0348-00</b>	3
54"	<b>F56M0354-00</b>	3
60"	<b>F56M0360-00</b>	3
66"	<b>F56M0366-00</b>	3
72"	<b>F56M0372-00</b>	3

Length	Modesty Panel
24"	<b>F57M1924-00</b>
30"	<b>F57M1930-00</b>
36"	<b>F57M1936-00</b>
42"	<b>F57M1942-00</b>
48"	<b>F57M1948-00</b>
54"	<b>F57M1954-00</b>
60"	<b>F57M1960-00</b>
66"	<b>F57M1966-00</b>
72"	<b>F57M1972-00</b>

### Alpha System Cart Worksurface

see page 58-59 for Worksurface Frames

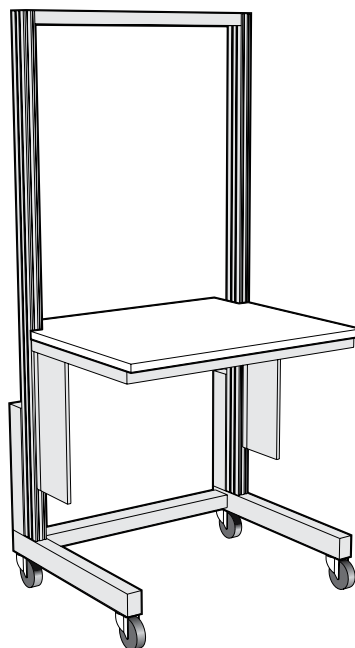

Length	Kemresin®	Phenolic Resin	High Pressure Laminate	
<b>24" TOP</b> for 23" deep frames	24"	<b>F58R3024-00</b>	<b>F58T3024-00</b>	<b>F58P3024-00</b>
	30"	<b>F58R3030-00</b>	<b>F58T3030-00</b>	<b>F58P3030-00</b>
	36"	<b>F58R3036-00</b>	<b>F58T3036-00</b>	<b>F58P3036-00</b>
	42"	<b>F58R3042-00</b>	<b>F58T3042-00</b>	<b>F58P3042-00</b>
	48"	<b>F58R3048-00</b>	<b>F58T3048-00</b>	<b>F58P3048-00</b>
	54"	<b>F58R3054-00</b>	<b>F58T3054-00</b>	<b>F58P3054-00</b>
	60"	<b>F58R3060-00</b>	<b>F58T3060-00</b>	<b>F58P3060-00</b>
	66"	<b>F58R3066-00</b>	<b>F58T3066-00</b>	<b>F58P3066-00</b>
72"	<b>F58R3072-00</b>	<b>F58T3072-00</b>	<b>F58P3072-00</b>	

Length	Kemresin®	Phenolic Resin	High Pressure Laminate	
<b>30" TOP</b> for 29" deep frames	24"	<b>F58R3624-00</b>	<b>F58T3624-00</b>	<b>F58P3624-00</b>
	30"	<b>F58R3630-00</b>	<b>F58T3630-00</b>	<b>F58P3630-00</b>
	36"	<b>F58R3636-00</b>	<b>F58T3636-00</b>	<b>F58P3636-00</b>
	42"	<b>F58R3642-00</b>	<b>F58T3642-00</b>	<b>F58P3642-00</b>
	48"	<b>F58R3648-00</b>	<b>F58T3648-00</b>	<b>F58P3648-00</b>
	54"	<b>F58R3654-00</b>	<b>F58T3654-00</b>	<b>F58P3654-00</b>
	60"	<b>F58R3660-00</b>	<b>F58T3660-00</b>	<b>F58P3660-00</b>
	66"	<b>F58R3666-00</b>	<b>F58T3666-00</b>	<b>F58P3666-00</b>
72"	<b>F58R3672-00</b>	<b>F58T3672-00</b>	<b>F58P3672-00</b>	

see page 58-59 for Worksurface Frames

# Heavy Duty Alpha System Cart

## Heavy Duty Alpha System Cart Assembly

SEFA 10 | Class 8 – Configuration 1 – Category 4

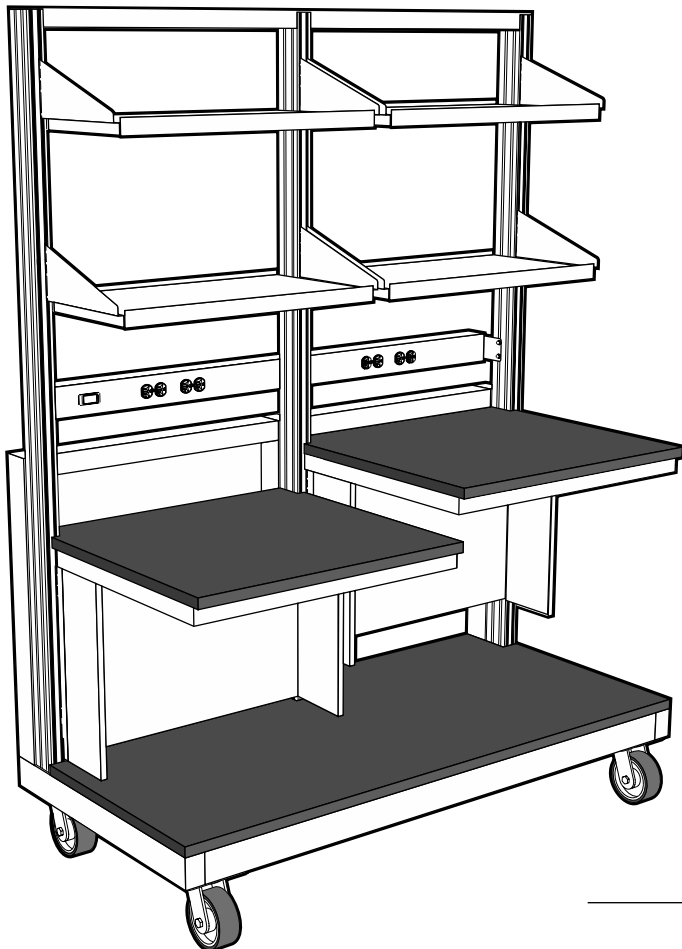

### Features:

- 3000 pound load capacity
- Two adjustable height, half-length, Kemresin Worktops with locking frames
- Worktops individually adjustable on 1" centers from 33" to 40"
- Four 15" deep, half-length, adjustable height, steel locking shelves with retaining lips on front and rear
- Shelves adjustable on 1" centers
- One 24" deep fixed, Kemresin shelf at base of bench
- One switched, adjustable height, power strip with four duplex receptacles and 10 foot pigtail
- Four heavy duty casters, with locking brakes on front casters
- Overall dimensions: 30" deep x 79½" high

### Heavy Duty Alpha System Cart Assembly

Length

48"	<b>F98-2448-00</b>
60"	<b>F98-2460-00</b>
72"	<b>F98-2472-00</b>

### Worksurface Color Option Code

#### Kemresin

**BK** = Black    **GR** = Grey    **PT**=Putty    **SL** = Slate

Kemresin is available in four standard colors. To specify Kemresin color, place a dash and the two-letter code at the end of the part number.

**Example:** F98-2448-00-**BK** for Black

If no color is specified, Kemresin will be furnished in Black.

# Mobile Base Cabinets

## Features:

### Steel Base Cabinets

- Furnished with finished ends and back.
- Cabinet tops available in either, Kemresin, Phenolic Resin, High Pressure Laminate or Steel.
- Furnished with two concealed, fixed casters at rear, and two swivel, locking casters at front.
- Furnished with interlocking drawer system and counterbalanced weights in drawer cabinets.
- Available in all steel cabinet styles, in both inset and full overlay.

### Wood Base Cabinets

- Furnished with finished veneer top, end panels, and back. End panels banded and finished, front, back, top, and bottom.
- Optional 1" thick cabinet tops available. (recommended for wood cabinets with pullboards)
- Furnished with two concealed, fixed casters at rear, and two swivel, locking casters at front.
- Furnished with interlocking drawer system and counterbalanced weights in drawer cabinets.
- Available in three wood cabinet styles in Oak, Maple, or Beech veneer.

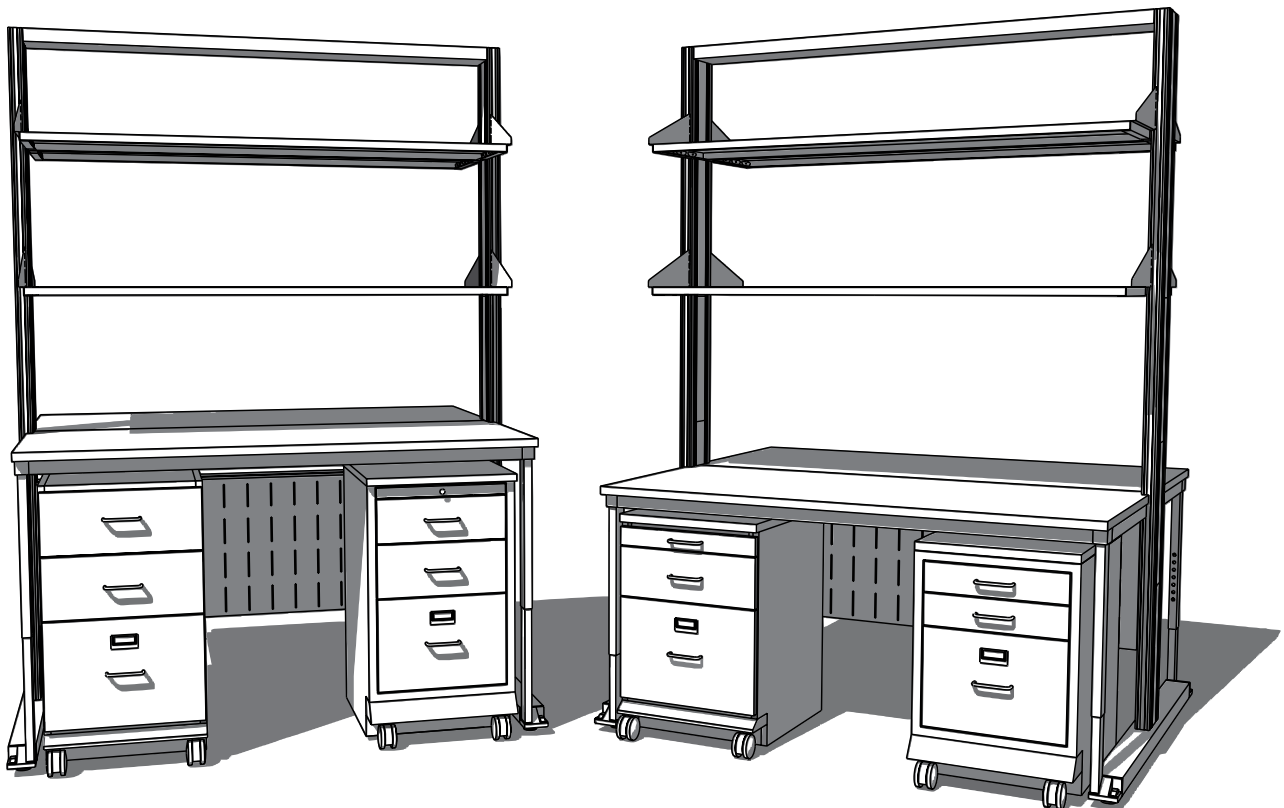

# Wood Sitting Height Mobile Cabinets

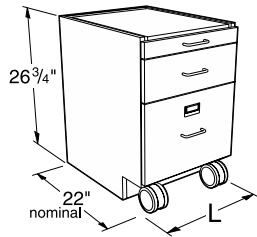

## Specifications:

These Mobile Cabinets are 26<sup>3</sup>/<sub>4</sub>" high and a nominal 22" deep. Lengths as shown. They are designed to fit under 30" high worksurface frames.

Drawer cabinets are furnished with counter weights, multiple-drawer cabinets include an interlock system. All mobile cabinets have finished backs.

**Note:** Last four digits of part number designates door and drawer head style, hinge, hardwood species, and pull selection. See page 99 for full explanation. Actual product may vary slightly from catalog illustration due to style and hardware selection.

### Cupboard Cabinets

### Cupboard Cabinets with Pullboards

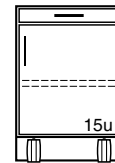
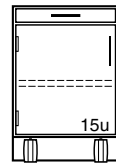
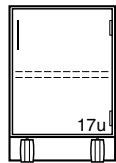
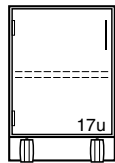

M10W272215L \_\_\_\_\_ 15"  
M10W272218L \_\_\_\_\_ 18"  
M10W272221L \_\_\_\_\_ 21"  
M10W272224L \_\_\_\_\_ 24"

M10W272215- \_\_\_\_\_ 15"  
M10W272218- \_\_\_\_\_ 18"  
M10W272221- \_\_\_\_\_ 21"  
M10W272224- \_\_\_\_\_ 24"

M15W272215L \_\_\_\_\_ 15"  
M15W272218L \_\_\_\_\_ 18"  
M15W272221L \_\_\_\_\_ 21"  
M15W272224L \_\_\_\_\_ 24"

M15W272215- \_\_\_\_\_ 15"  
M15W272218- \_\_\_\_\_ 18"  
M15W272221- \_\_\_\_\_ 21"  
M15W272224- \_\_\_\_\_ 24"

### Drawer/Cupboard Cabinets

### Drawer/Cupboard Cabinets with Pullboards

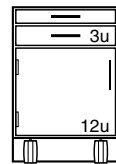
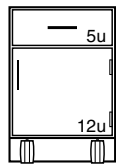
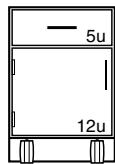

M20W272215L \_\_\_\_\_ 15"  
M20W272218L \_\_\_\_\_ 18"  
M20W272221L \_\_\_\_\_ 21"  
M20W272224L \_\_\_\_\_ 24"

M20W272215- \_\_\_\_\_ 15"  
M20W272218- \_\_\_\_\_ 18"  
M20W272221- \_\_\_\_\_ 21"  
M20W272224- \_\_\_\_\_ 24"

M25W272215L \_\_\_\_\_ 15"  
M25W272218L \_\_\_\_\_ 18"  
M25W272221L \_\_\_\_\_ 21"  
M25W272224L \_\_\_\_\_ 24"

M25W272215- \_\_\_\_\_ 15"  
M25W272218- \_\_\_\_\_ 18"  
M25W272221- \_\_\_\_\_ 21"  
M25W272224- \_\_\_\_\_ 24"

### Drawer Cabinets

### Drawer Cabinets with Pullboards

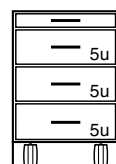
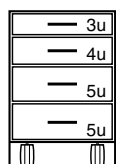
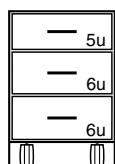

M30W272215- \_\_\_\_\_ 15"  
M30W272218- \_\_\_\_\_ 18"  
M30W272221- \_\_\_\_\_ 21"  
M30W272224- \_\_\_\_\_ 24"

M40W272215- \_\_\_\_\_ 15"  
M40W272218- \_\_\_\_\_ 18"  
M40W272221- \_\_\_\_\_ 21"  
M40W272224- \_\_\_\_\_ 24"

M35W272215- \_\_\_\_\_ 15"  
M35W272218- \_\_\_\_\_ 18"  
M35W272221- \_\_\_\_\_ 21"  
M35W272224- \_\_\_\_\_ 24"

**Note:** Wood Mobile Cabinets are constructed with finished top panels. Tops may be added but are not required to close the top of the cabinet.

Tops are recommended on wood mobile cabinets with pullboards.

**Tops must be ordered separately.** (see page 133)

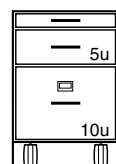
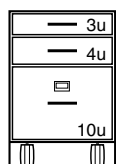
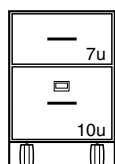

M60W272215- \_\_\_\_\_ 15"  
M60W272218- \_\_\_\_\_ 18"  
M60W272221- \_\_\_\_\_ 21"  
M60W272224- \_\_\_\_\_ 24"

M62W272215- \_\_\_\_\_ 15"  
M62W272218- \_\_\_\_\_ 18"  
M62W272221- \_\_\_\_\_ 21"  
M62W272224- \_\_\_\_\_ 24"

M65W272215- \_\_\_\_\_ 15"  
M65W272218- \_\_\_\_\_ 18"  
M65W272221- \_\_\_\_\_ 21"  
M65W272224- \_\_\_\_\_ 24"

# Wood Standing Height Mobile Cabinets

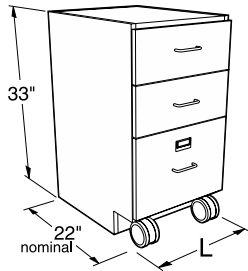

### Specifications:

These Mobile Cabinets are 33" high and a nominal 22" deep. Lengths as shown. They are designed to fit under 36" high worksurface frames.

Drawer cabinets are furnished with counter weights, multiple-drawer cabinets include an interlock system. All mobile cabinets have finished backs.

**Note:** Last four digits of part number designates door and drawer head style, hinge, hardwood species, and pull selection. See page 99 for full explanation. Actual product may vary slightly from catalog illustration due to style and hardware selection.

### Cupboard Cabinets

### Cupboard Cabinets with Pullboards

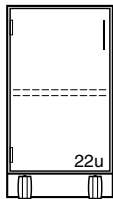

- M10W332215L \_\_\_\_\_ 15"L
- M10W332218L \_\_\_\_\_ 18"L
- M10W332221L \_\_\_\_\_ 21"L
- M10W332224L \_\_\_\_\_ 24"L

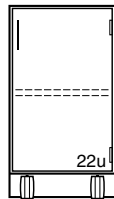

- M10W332215- \_\_\_\_\_ 15"L
- M10W332218- \_\_\_\_\_ 18"L
- M10W332221- \_\_\_\_\_ 21"L
- M10W332224- \_\_\_\_\_ 24"L

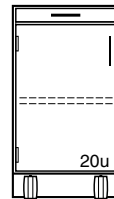

- M15W332215L \_\_\_\_\_ 15"L
- M15W332218L \_\_\_\_\_ 18"L
- M15W332221L \_\_\_\_\_ 21"L
- M15W332224L \_\_\_\_\_ 24"L

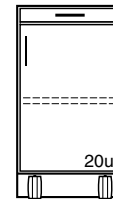

- M15W332215- \_\_\_\_\_ 15"L
- M15W332218- \_\_\_\_\_ 18"L
- M15W332221- \_\_\_\_\_ 21"L
- M15W332224- \_\_\_\_\_ 24"L

### Drawer/Cupboard Cabinets

### Drawer/Cupboard Cabinets with Pullboards

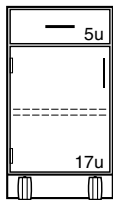

- M20W332215L \_\_\_\_\_ 15"L
- M20W332218L \_\_\_\_\_ 18"L
- M20W332221L \_\_\_\_\_ 21"L
- M20W332224L \_\_\_\_\_ 24"L

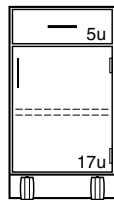

- M20W332215- \_\_\_\_\_ 15"L
- M20W332218- \_\_\_\_\_ 18"L
- M20W332221- \_\_\_\_\_ 21"L
- M20W332224- \_\_\_\_\_ 24"L

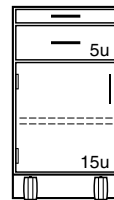

- M25W332215L \_\_\_\_\_ 15"L
- M25W332218L \_\_\_\_\_ 18"L
- M25W332221L \_\_\_\_\_ 21"L
- M25W332224L \_\_\_\_\_ 24"L

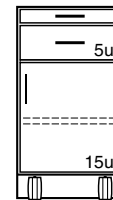

- M25W332215- \_\_\_\_\_ 15"L
- M25W332218- \_\_\_\_\_ 18"L
- M25W332221- \_\_\_\_\_ 21"L
- M25W332224- \_\_\_\_\_ 24"L

### Drawer Cabinets

### Drawer Cabinets with Pullboards

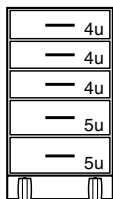

- M50W332215- \_\_\_\_\_ 15"L
- M50W332218- \_\_\_\_\_ 18"L
- M50W332221- \_\_\_\_\_ 21"L
- M50W332224- \_\_\_\_\_ 24"L

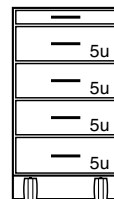

- M45W332215- \_\_\_\_\_ 15"L
- M45W332218- \_\_\_\_\_ 18"L
- M45W332221- \_\_\_\_\_ 21"L
- M45W332224- \_\_\_\_\_ 24"L

**Note:** Wood Mobile Cabinets are constructed with finished top panels. Tops may be added but are not required to close the top of the cabinet.

Tops are recommended on wood mobile cabinets with pullboards.

**Tops must be ordered separately.** (see page 133)

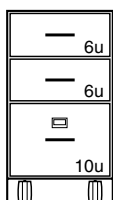

- M62W332215- \_\_\_\_\_ 15"L
- M62W332218- \_\_\_\_\_ 18"L
- M62W332221- \_\_\_\_\_ 21"L
- M62W332224- \_\_\_\_\_ 24"L

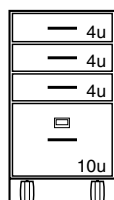

- M63W332215- \_\_\_\_\_ 15"L
- M63W332218- \_\_\_\_\_ 18"L
- M63W332221- \_\_\_\_\_ 21"L
- M63W332224- \_\_\_\_\_ 24"L

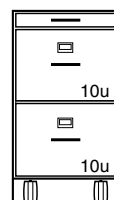

- M75W332215- \_\_\_\_\_ 15"L
- M75W332218- \_\_\_\_\_ 18"L
- M75W332221- \_\_\_\_\_ 21"L
- M75W332224- \_\_\_\_\_ 24"L

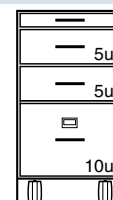

- M67W332215- \_\_\_\_\_ 15"L
- M67W332218- \_\_\_\_\_ 18"L
- M67W332221- \_\_\_\_\_ 21"L
- M67W332224- \_\_\_\_\_ 24"L

# Steel Sitting Height Mobile Cabinets

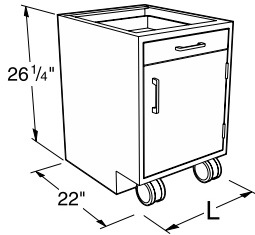

## Specifications

Steel Sitting Height Mobile Cabinets are 26 1/4" high and 22" deep. Lengths as shown. Designed to fit under 30" high workstation frames.

Drawer cabinets are furnished with counter weights, multiple-drawer cabinets include an interlock system. All mobile cabinets have finished backs.

**Note:** Last four digits of part number designates door and drawer head style, hinge, hardwood species and pull selection. See page 98 for full explanation. Actual product may vary slightly from catalog illustration due to style and hardware selection.

## Cupboard Cabinets

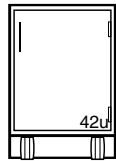
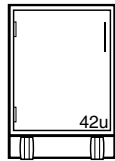

**Note:** Steel Mobile Cabinets are constructed with open top frames. Tops are required to close the top of the cabinets.

**Tops must be ordered separately.**  
(see page 132 & 133)

M10C262215L	15"L	M10C262215-	15"L
M10C262218L	18"L	M10C262218-	18"L
M10C262221L	21"L	M10C262221-	21"L
M10C262224L	24"L	M10C262224-	24"L

## Drawer/Cupboard Cabinets

## Drawer/Cupboard Cabinets with Pullboards

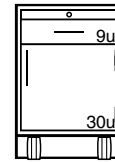
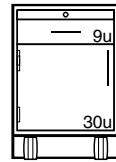
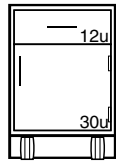
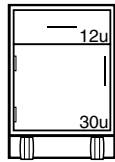

M20C262215L	15"L	M20C262215-	15"L
M20C262218L	18"L	M20C262218-	18"L
M20C262221L	21"L	M20C262221-	21"L
M20C262224L	24"L	M20C262224-	24"L

M25C262215L	15"L	M25C262215-	15"L
M25C262218L	18"L	M25C262218-	18"L
M25C262221L	21"L	M25C262221-	21"L
M25C262224L	24"L	M25C262224-	24"L

## Drawer Cabinets

## Drawer Cabinets with Pullboards

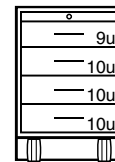
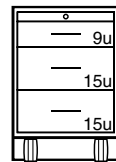
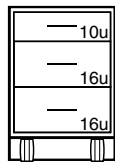

M30C262215-	15"L
M30C262218-	18"L
M30C262221-	21"L
M30C262224-	24"L

M35C262215-	15"L
M35C262218-	18"L
M35C262221-	21"L
M35C262224-	24"L

M45C262215-	15"L
M45C262218-	18"L
M45C262221-	21"L
M45C262224-	24"L

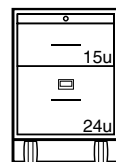
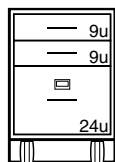

M62C262215-	15"L
M62C262218-	18"L
M62C262221-	21"L
M62C262224-	24"L

M66C262215-	15"L
M66C262218-	18"L
M66C262221-	21"L
M66C262224-	24"L



# Steel Standing Height Mobile Cabinets

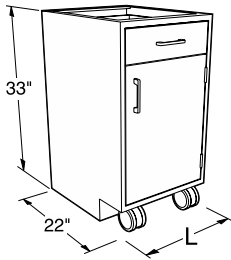

## Specifications

Steel Standing Height Mobile Cabinets are 33" high and 22" deep. Lengths as shown. Designed to fit under 36" high workstation frames.

Drawer cabinets are furnished with counter weights, multiple-drawer cabinets include an interlock system. All mobile cabinets have finished backs.

**Note:** Last four digits of part number designates door and drawer head style, hinge, hardwood species and pull selection. See page 98 for full explanation. Actual product may vary slightly from catalog illustration due to style and hardware selection.

## Cupboard Cabinets

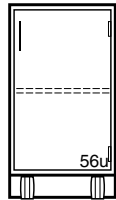
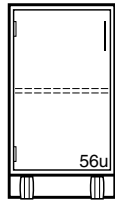

- M10C332215L \_\_\_\_\_ 15"L
- M10C332218L \_\_\_\_\_ 18"L
- M10C332221L \_\_\_\_\_ 21"L
- M10C332224L \_\_\_\_\_ 24"L

- M10C332215- \_\_\_\_\_ 15"L
- M10C332218- \_\_\_\_\_ 18"L
- M10C332221- \_\_\_\_\_ 21"L
- M10C332224- \_\_\_\_\_ 24"L

**Note:** Steel Mobile Cabinets are constructed with open top frames. Tops are required to close the top of the cabinets.

**Tops must be ordered separately.**  
(see page 132 & 133)

## Drawer/Cupboard Cabinets

## Drawer/Cupboard Cabinets with Pullboards

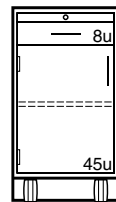
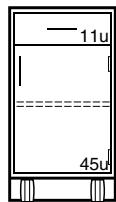
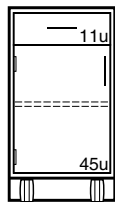

- M20C332215L \_\_\_\_\_ 15"L
- M20C332218L \_\_\_\_\_ 18"L
- M20C332221L \_\_\_\_\_ 21"L
- M20C332224L \_\_\_\_\_ 24"L

- M20C332215- \_\_\_\_\_ 15"L
- M20C332218- \_\_\_\_\_ 18"L
- M20C332221- \_\_\_\_\_ 21"L
- M20C332224- \_\_\_\_\_ 24"L

- M25C332215L \_\_\_\_\_ 15"L
- M25C332218L \_\_\_\_\_ 18"L
- M25C332221L \_\_\_\_\_ 21"L
- M25C332224L \_\_\_\_\_ 24"L

- M25C332215- \_\_\_\_\_ 15"L
- M25C332218- \_\_\_\_\_ 18"L
- M25C332221- \_\_\_\_\_ 21"L
- M25C332224- \_\_\_\_\_ 24"L

## Drawer Cabinets

## Drawer Cabinets with Pullboards

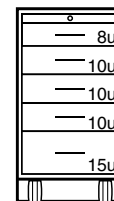
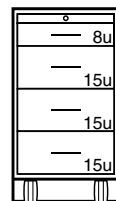
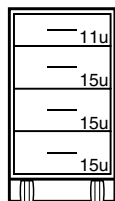

- M40C332215- \_\_\_\_\_ 15"L
- M40C332218- \_\_\_\_\_ 18"L
- M40C332221- \_\_\_\_\_ 21"L
- M40C332224- \_\_\_\_\_ 24"L

- M46C332215- \_\_\_\_\_ 15"L
- M46C332218- \_\_\_\_\_ 18"L
- M46C332221- \_\_\_\_\_ 21"L
- M46C332224- \_\_\_\_\_ 24"L

- M56C332215- \_\_\_\_\_ 15"L
- M56C332218- \_\_\_\_\_ 18"L
- M56C332221- \_\_\_\_\_ 21"L
- M56C332224- \_\_\_\_\_ 24"L

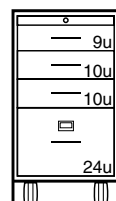
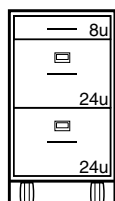

- M71C332215- \_\_\_\_\_ 15"L
- M71C332218- \_\_\_\_\_ 18"L
- M71C332221- \_\_\_\_\_ 21"L
- M71C332224- \_\_\_\_\_ 24"L

- M68C332215- \_\_\_\_\_ 15"L
- M68C332218- \_\_\_\_\_ 18"L
- M68C332221- \_\_\_\_\_ 21"L
- M68C332224- \_\_\_\_\_ 24"L

Illustrations and specifications are based on most current design and production information available. Kewaunee reserves the right to make changes at any time without notice.

# Mobile Cabinet Tops & Accessories

## Specifications:

**1" Thick Mobile Cabinet Tops** are available in three depths, 22", 23", or 24" and three materials: Kemresin, Phenolic Resin or Plastic Laminate. They may be used on any Mobile

Cabinet and add 1" to the overall height of the cabinets. All edges of top are finished.

### 1" Thick — Mobile Cabinet Top (adds 1" to height of Mobile Cabinet)

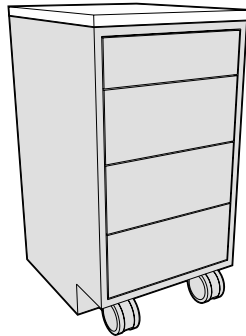

#### 22" Deep flush to front of case

Length	Kemresin®	Kemresin Colors	Black Phenolic Resin	Black Plastic Laminate
15"	<b>F94R2215-00-__</b>	<b>BK = Black</b>	<b>F94T2215-00</b>	<b>F94P2215-00</b>
18"	<b>F94R2218-00-__</b>	<b>GR = Grey</b>	<b>F94T2218-00</b>	<b>F94P2218-00</b>
21"	<b>F94R2221-00-__</b>	<b>PT = Putty</b>	<b>F94T2221-00</b>	<b>F94P2221-00</b>
24"	<b>F94R2224-00-__</b>	<b>SL = Slate</b>	<b>F94T2224-00</b>	<b>F94P2224-00</b>
30"	<b>F94R2230-00-__</b>		<b>F94T2230-00</b>	<b>F94P2230-00</b>
36"	<b>F94R2236-00-__</b>		<b>F94T2236-00</b>	<b>F94P2236-00</b>
42"	<b>F94R2242-00-__</b>		<b>F94T2242-00</b>	<b>F94P2242-00</b>
48"	<b>F94R2248-00-__</b>		<b>F94T2248-00</b>	<b>F94P2248-00</b>

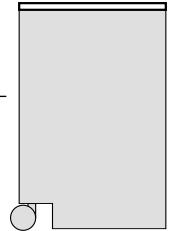

*Inset Cabinet End View*

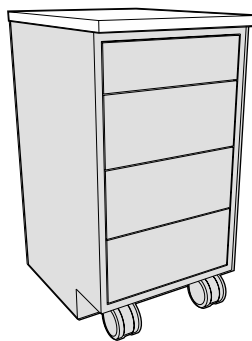

#### 23" Deep flush to overlay door/drawer fronts - 1" overhang of case

Length	Kemresin®	Kemresin Colors	Black Phenolic Resin	Black Plastic Laminate
15"	<b>F94R2315-00-__</b>	<b>BK = Black</b>	<b>F94T2315-00</b>	<b>F94P2315-00</b>
18"	<b>F94R2318-00-__</b>	<b>GR = Grey</b>	<b>F94T2318-00</b>	<b>F94P2318-00</b>
21"	<b>F94R2321-00-__</b>	<b>PT = Putty</b>	<b>F94T2321-00</b>	<b>F94P2321-00</b>
24"	<b>F94R2324-00-__</b>	<b>SL = Slate</b>	<b>F94T2324-00</b>	<b>F94P2324-00</b>
30"	<b>F94R2330-00-__</b>		<b>F94T2330-00</b>	<b>F94P2330-00</b>
36"	<b>F94R2336-00-__</b>		<b>F94T2336-00</b>	<b>F94P2336-00</b>
42"	<b>F94R2342-00-__</b>		<b>F94T2342-00</b>	<b>F94P2342-00</b>
48"	<b>F94R2348-00-__</b>		<b>F94T2348-00</b>	<b>F94P2348-00</b>

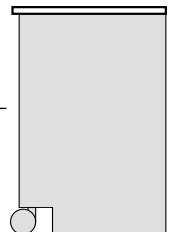

*Inset Cabinet End View*

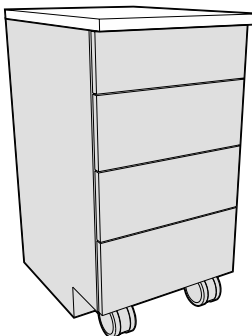

#### 24" Deep 1" overhang of overlay door/drawer fronts

Length	Kemresin®	Kemresin Colors	Black Phenolic Resin	Black Plastic Laminate
15"	<b>F94R2415-00-__</b>	<b>BK = Black</b>	<b>F94T2415-00</b>	<b>F94P2415-00</b>
18"	<b>F94R2418-00-__</b>	<b>GR = Grey</b>	<b>F94T2418-00</b>	<b>F94P2418-00</b>
21"	<b>F94R2421-00-__</b>	<b>PT = Putty</b>	<b>F94T2421-00</b>	<b>F94P2421-00</b>
24"	<b>F94R2424-00-__</b>	<b>SL = Slate</b>	<b>F94T2424-00</b>	<b>F94P2424-00</b>
30"	<b>F94R2430-00-__</b>		<b>F94T2430-00</b>	<b>F94P2430-00</b>
36"	<b>F94R2436-00-__</b>		<b>F94T2436-00</b>	<b>F94P2436-00</b>
42"	<b>F94R2442-00-__</b>		<b>F94T2442-00</b>	<b>F94P2442-00</b>
48"	<b>F94R2448-00-__</b>		<b>F94T2448-00</b>	<b>F94P2448-00</b>

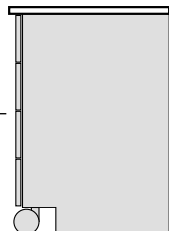

*Overlay Cabinet End View*

# Mobile Cabinet Tops & Accessories

**Specifications:**

**Steel Mobile Cabinet Tops** are fabricated from 18 gauge steel and finished to match the cabinet. They are designed for Steel Mobile Cabinets only.

**Mobile Cabinet Grabbar** allows easier movement and relocation of mobile cabinets. Fabricated from powder coated steel or stainless steel, they may be used on any

Mobile Cabinet, with or without Tops. Bars must be attached in field with supplied screws and/or bolts.

**22" Deep — Steel — Mobile Cabinet Top (adds less than 1/4" to height of Mobile Cabinet)**

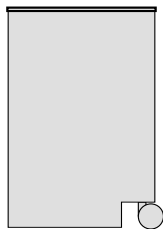
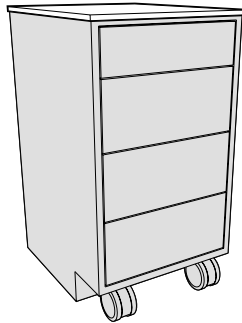

*Inset Cabinet  
End View*

**22" Deep Top**  
*for Steel Mobile Cabinets only*

Lg	Painted Steel	Stainless Steel
15"	<b>F94M2215-00</b>	<b>F94S2215-00</b>
18"	<b>F94M2218-00</b>	<b>F94S2218-00</b>
21"	<b>F94M2221-00</b>	<b>F94S2221-00</b>
24"	<b>F94M2224-00</b>	<b>F94S2224-00</b>
30"	<b>F94M2230-00</b>	<b>F94S2230-00</b>
36"	<b>F94M2236-00</b>	<b>F94S2236-00</b>
42"	<b>F94M2242-00</b>	<b>F94S2242-00</b>
48"	<b>F94M2248-00</b>	<b>F94S2248-00</b>

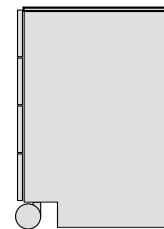

*Overlay Cabinet  
End View*

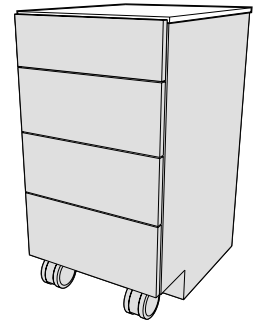

**23" Deep — Steel — Mobile Cabinet Top (adds 1/2" to height of Mobile Cabinet)**

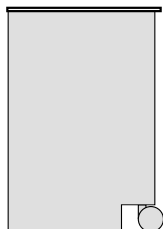
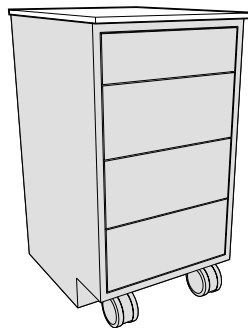

*Inset Cabinet  
End View*

**23" Deep Top**  
*for Steel Mobile Cabinets only*

Lg	Painted Steel	Stainless Steel
15"	<b>F94M2315-00</b>	<b>F94S2315-00</b>
18"	<b>F94M2318-00</b>	<b>F94S2318-00</b>
21"	<b>F94M2321-00</b>	<b>F94S2321-00</b>
24"	<b>F94M2324-00</b>	<b>F94S2324-00</b>
30"	<b>F94M2330-00</b>	<b>F94S2330-00</b>
36"	<b>F94M2336-00</b>	<b>F94S2336-00</b>
42"	<b>F94M2342-00</b>	<b>F94S2342-00</b>
48"	<b>F94M2348-00</b>	<b>F94S2348-00</b>

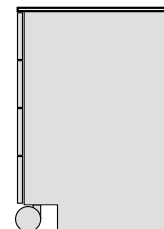

*Overlay Cabinet  
End View*

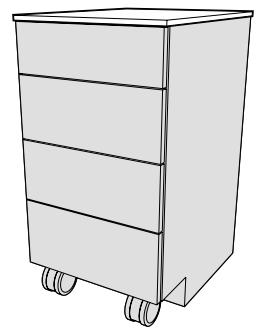

**Mobile Cabinet Grabbar**

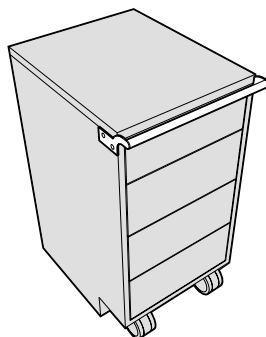

Length	Painted Steel	Stainless Steel
15"	<b>F73M0015-00</b>	<b>F73S0015-00</b>
18"	<b>F73M0018-00</b>	<b>F73S0018-00</b>
21"	<b>F73M0021-00</b>	<b>F73S0021-00</b>
24"	<b>F73M0024-00</b>	<b>F73S0024-00</b>

